

NEW!!!
BOYD BOOMS @ BOYD AG, LLC
THE Z-FOLD BOOM !
THE MOST EXCITING BOOM FROM BOYD AG, LLC !!!

FEATURES INCLUDE:
FASTER FOLD WITH ELECTRONIC SPEED RAMPING OF ALL BOOM SECTIONS
LONGER BOOM LENGTHS
ALL BOOMS CAN BE FOLDED AT THE SAME TIME OR IDEPENDENTLY

60' SPRAY PATTERN



SPRAY AT MULTIPLE LENGTHS, EXAMPLE:
60', 90', 120', 132', AND MORE, THE BEST BOOM IN THE INDUSTRY WITH
MORE FLEXIBILITY. AVAILABLE IN MANY DIFFERENT CONFIGURATIONS
WITH MANY STANDARD OPTIONS, TUNNEL BOOM DESIGN...

90' SPRAY PATTERN

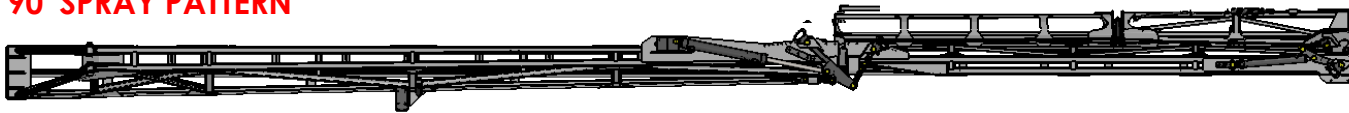

120' SPRAY PATTERN



ZF6912 - MID FOLD - 60' EXTENDING TO 120'

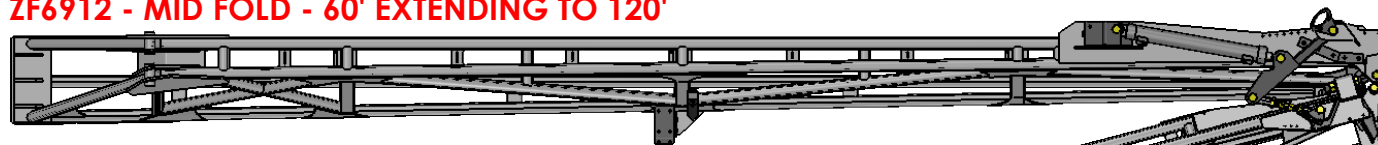

REAR FOLDING DESIGN WITH
SIMULTANEOUS CYLINDER ACTUATION
ALLOWS FOR FASTER FOLD / UNFOLD
TIMES WHEN COMPARED TO FRONT
FOLDING MULTI-WIDTH BOOMS.

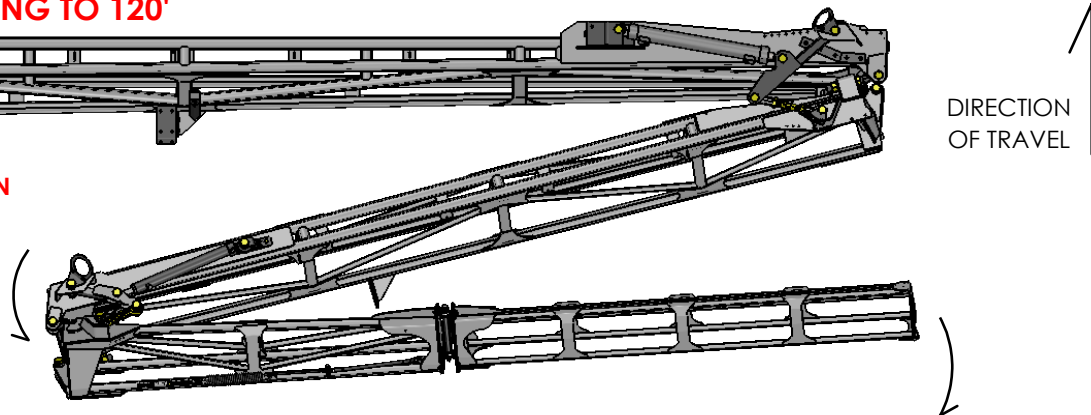

DIRECTION
OF TRAVEL



3208 Sierra Drive
Georgetown, TX 78628
(800) 637-7884

<https://www.boydag.com/> - <https://www.superspraybooms.com/>

BI-FOLD TRANSPORT CONFIGURATION (ZF6912 SHOWN)

ALLOWS FOR FASTER FOLD/UNFOLD TIMES GOING FROM TRANSPORT POSITION TO 120' SPRAY WIDTH AND A NARROWER OVERALL UNIT WIDTH.

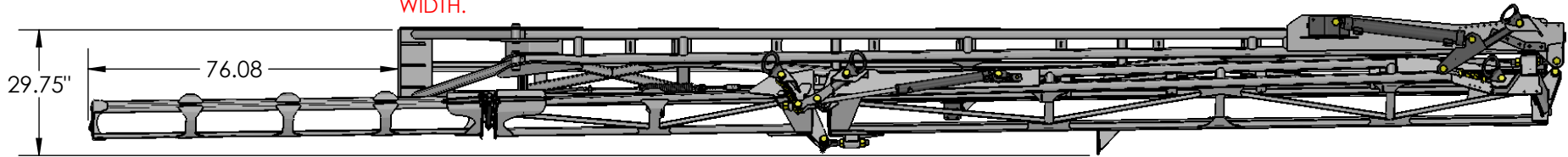

TRI-FOLD TRANSPORT CONFIGURATION (ZF6912 SHOWN)

ALLOWS FOR FASTER FOLD/UNFOLD TIMES GOING FROM TRANSPORT POSITION TO 60' AND 90' SPRAY WIDTHS.

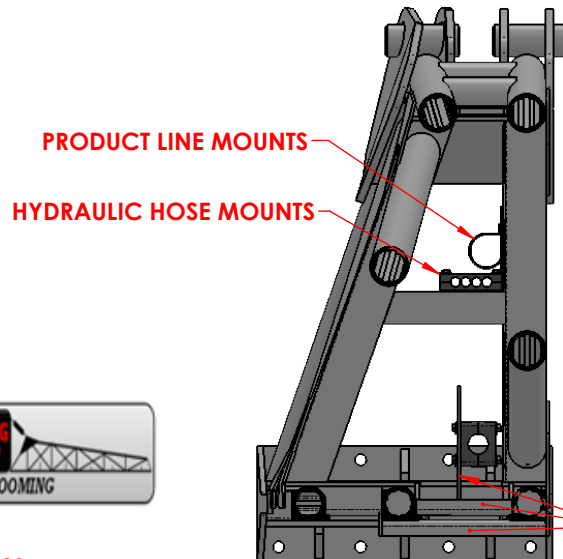
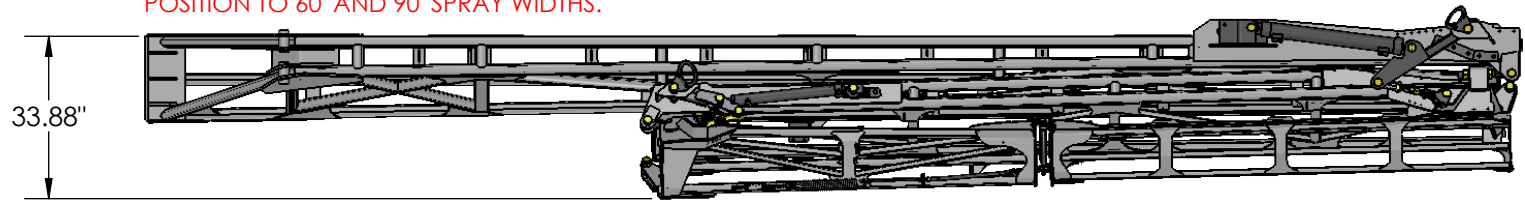

TUNNEL BOOM EQUALS VERSILITY

THE Z-FOLD INCORPORATES A TUNNEL BOOM DESIGN IN EACH OF THE BOOM SECTIONS. COUPLED WITH THE ADJUSTABLE BOLT-ON PIPE MOUNTS IT ALLOWS FOR A NEARLY UNLIMITED NUMBER OF DIFFERENT NOZZLE SPACINGS. CONVERSION FROM ONE NOZZLE SPACING TO ANOTHER REQUIRES NO MODIFICATIONS TO BOOM SECTION BODIES. PRODUCT AND HYDRAULIC LINES ARE RUN INSIDE BOOM FRAME ALSO.

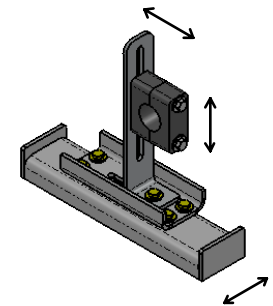

BOLT-ON PIPE MOUNT ASSY



3208 Sierra Drive
Georgetown, TX 78628
(800) 637-7884

<https://www.boydag.com/> - <https://www.superspraybooms.com/>